

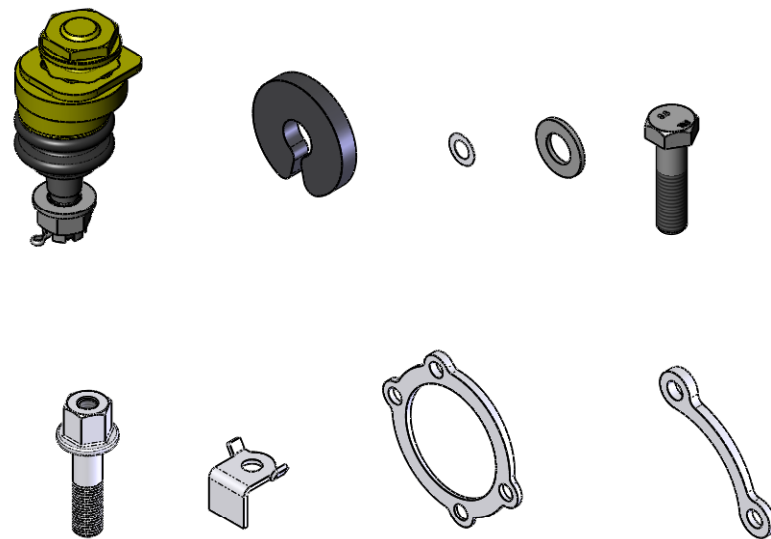

721231 Kit, Upper Control Arm - Left

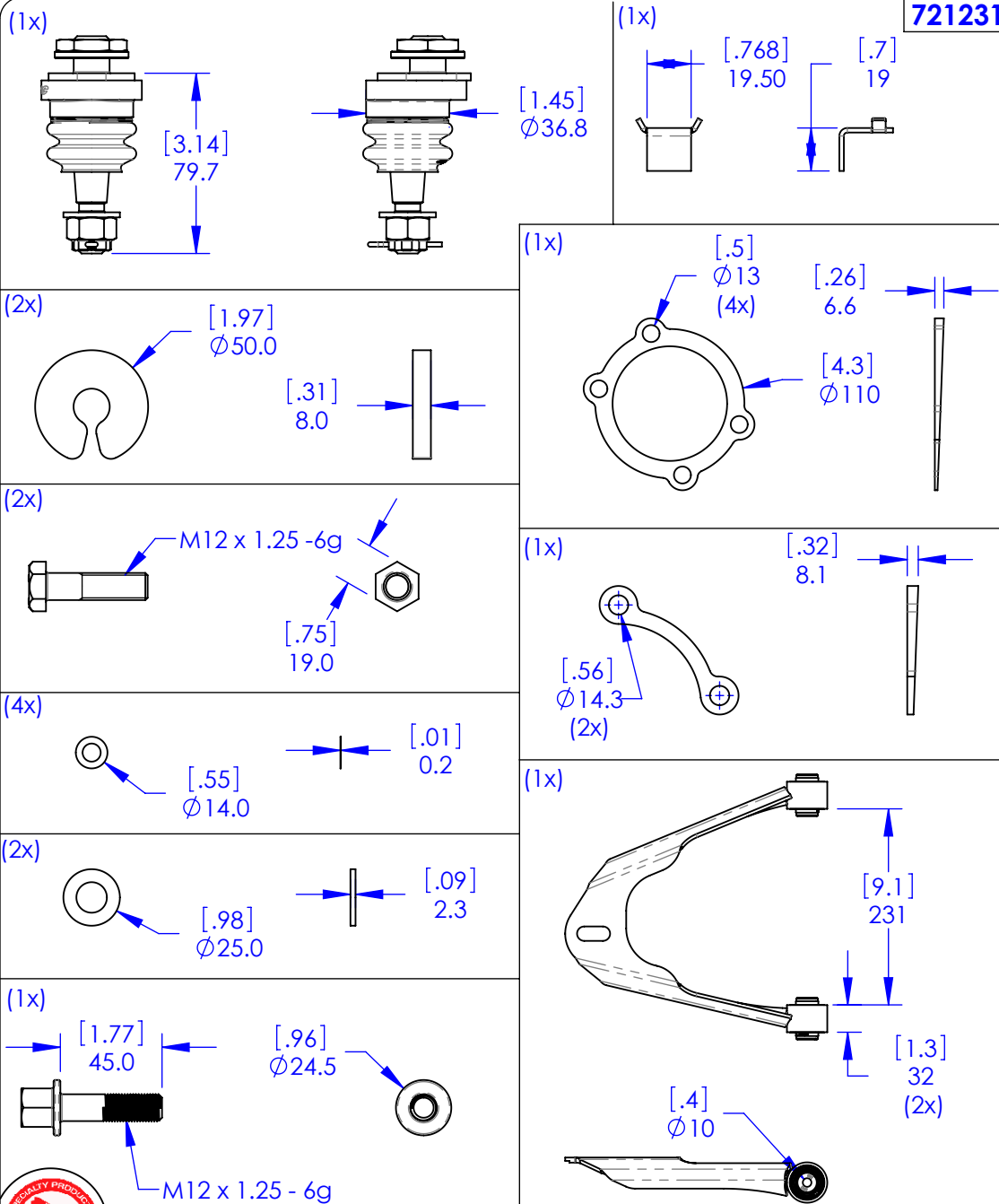

 **Specialty Products Company**
 Longmont, Colorado USA • www.specprod.com

721231 Kit, Upper Control Arm - Left

PROPRIETARY AND CONFIDENTIAL
 THIS DOCUMENT CONTAINS PROPRIETARY INFORMATION WHICH SHALL NOT BE REPRODUCED, TRANSFERRED TO OTHER DOCUMENTS, DISCLOSED TO OTHERS, USED FOR MANUFACTURING, OR ANY OTHER PURPOSE WITHOUT PRIOR WRITTEN PERMISSION FROM SPECIALTY PRODUCTS COMPANY

FOR RECEIVING-INSPECTION USE

Rev. **K**
 09 Jan 14